



ROBOTIC
WELDING/
CUTTING
TECHNOLOGIES



You can visit to get to
know us better and
see all of our links.



People > Environment > Quality > Cost > Machine

INTECRO specializes in utilizing cutting-edge technologies such as robotics, mechatronics, and industrial automation to enhance the productivity and profitability of its clients. Metalworking solutions, which include robotic welding and cutting, mechanical factory automation solutions, and automated assembly lines, are impeccably designed with a customer-centric approach that prioritizes meeting the ever-changing demands of the global business landscape and fierce competition.



A. Ali ŞEN - CEO

"At INTECRO, we strongly hold the view that robotic welding technologies have the capacity to offer immense value to various industries outside the automotive sector. We are committed to catering to the manufacturing needs of global manufacturers by providing tailored solutions that guarantee effectiveness. Our ultimate objective is to broaden our customer base worldwide, as we remain committed to delivering exceptional services."

Cihan ŞENSOY - CTO

"INTECRO creates value for industrial production with its emphasis on project management discipline, ever-increasing experience and customer satisfaction."



Cem DEŞEN - CBDO

"INTECRO responds to its customers' requirements by "creating and realizing the most efficient method" rather than "providing solutions within the limits of the existing technology". The understanding that "nothing is impossible" is key in the success of INTECRO's solutions for the most challenging applications."



R.Serhat UĞURAL - Vice President

"My journey with INTECRO has been one marked by financial stability, unwavering credibility, and a commitment to customer satisfaction that sets an industry benchmark. Our reliability is the cornerstone of a partnership that offers peace of mind, allowing clients to pursue their financial goals with confidence."



INTECRO Robotics

Milestone

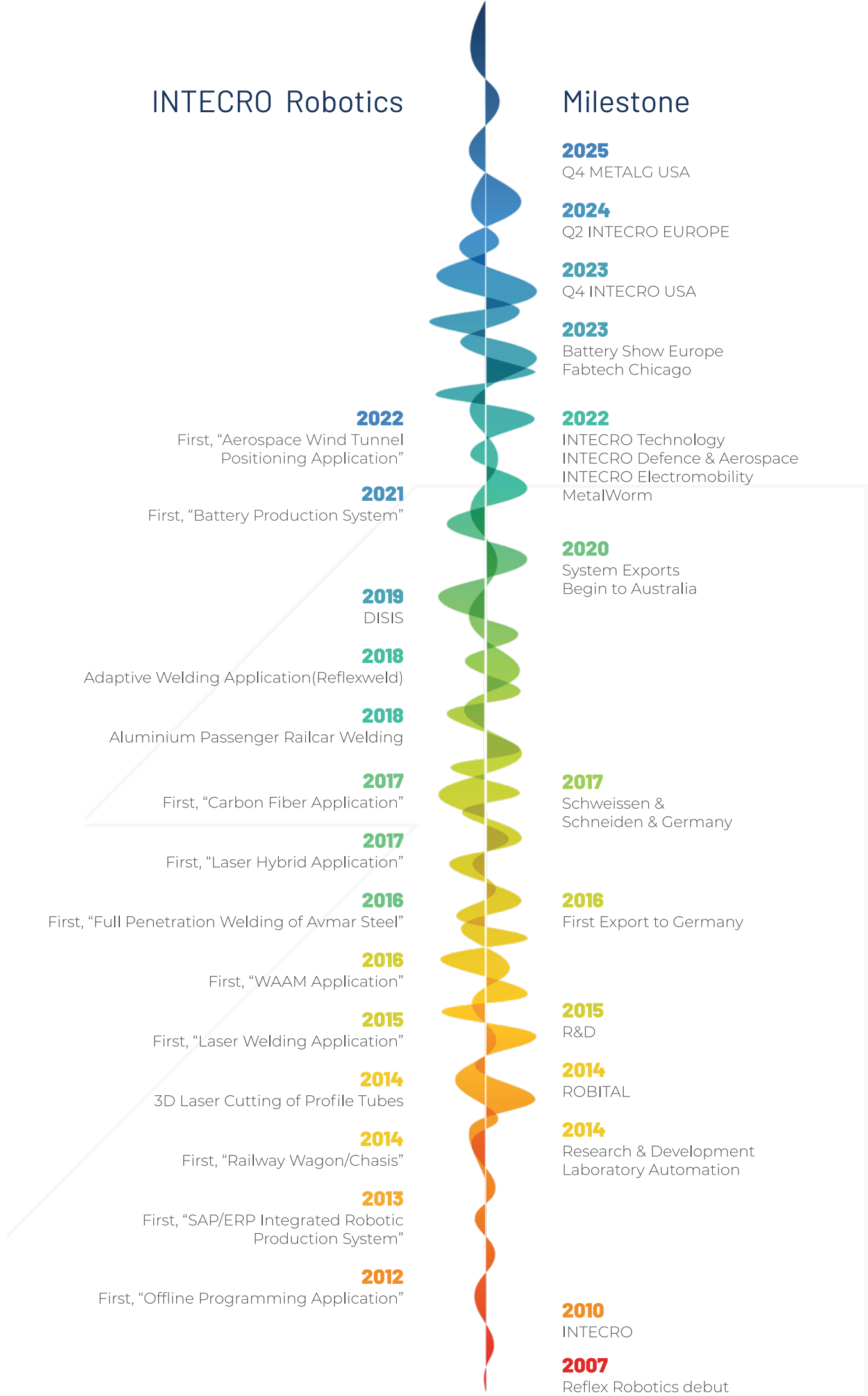

Expertise & Andication



Qualified Labor Force

+214 Staff

+124 Engineers

and higher level technical personnel.



Working Areas

Ankara HQ 8000 m² Facilities Manufacturing/Integration Area
General Industry, Defence & Aerospace, Research & Development

Via Tower Office Sales & Marketing

Bursa 2000 m² Facilities Manufacturing/Integration Area
E-Mobility and Automotive Engineering

Efe Tower Offices Project Management

USA Sales Office

Ankara Hab Integration Plant Area



Strong Financial Structure

- Bank guarantees backed up by high credibility.
- Cash reserves for purchasing



Software Infrastructure

- 3D Design, 3D Simulation / PLM,
- 3D CAD-CAM and analysis capabilities
- ERP, MRP, CRM, PMS, Robot Simulation, ANSYS Analysis



Management Systems

- ERP, MRP, CRM and PMS management with cloud distribution, secure local server infrastructure for storage of confidential customer data.



Certificates and Competencies

- CE Certificate for all products, ISO 9001,
- Technological Product Experience Certificate.



Preferred Supplier

- Installed base of more than 403 systems and more than 40 repeat orders.



Pre-Sales Services

- Integrated Technologies such as; ArcSense, Multi-Pass and Laser Camera Seam Tracker.
- Test Stations for performing tests in order to quantify quality parameters through PQR, Xray Control, Destructive Testing and Micro Structure Analysis.



Partnership

- Global network of technology partners and suppliers.



After-Sales Services

- Local sales and technical support based in Europe. Future expansion for the America, Middle-East and Asia.



Production

- Plasma and saw-cutting machines, robotic and manual welding, stress relieving technology, vertical machining center, CNC milling and turning machines, press brake, sandblasting and painting chambers, quality control devices, assembly stations and fixture manufacturing capabilities. Robotic external axes welded with robots: Sliders, positioners and gantry system components. Production capacity of 2.000 tons / year for single-shift.

Team

INTECRO has made significant investments in human resources since 2007, starting with internships. By providing long-term career planning, we became a top choice for both new graduates and professionals. Our talent acquisition strategy has resulted in a dedicated and motivated team committed to success.



Total Number Of Employees Engineering Manufacturing Administration

214 68 % 17 % 15 %

Our company staff consists of **Electrical, Electronic, Mechatronics, Metallurgical, Machinery, Industrial Engineers** and technicians who are experts in their fields and experienced in their field of technology. **The Design, Project, Production, Assembly, Service, Sales and Marketing teams** and R&D personnel in our project offices and workshop are organized ready to serve our customers.



MORE INNOVATION

We are aware of the strong influence of innovation in our lives. For this reason we are strongly connected to Industrial and Social Innovation. Our motivation is to move forward with more innovation, more curiosity and a sense of research for applying new technologies in the field of robotics.









THE INTECRO TECHNICAL TEAM IS CUSTOMER FOCUSED.

"The team that develops and realizes the ideal solution in each project keeps an optimistic mindset in customer relations and approach each case with empathy when faced with technical challenges. The sense of customer satisfaction that has come into existence since the establishment of the company has evolved into a company culture that forms the backbone of INTECRO"



CİHAN ŞENSOY
CTO



-  Mechanical Engineer
-  Mechatronics Engineer
-  Metallurgical Engineer
-  Electrical Electronics Engineer
-  Control Engineer
-  Automotive Engineer
-  Welding and Metallurgical Engineer
-  Computer Engineer
-  Industrial Engineer



+14 YEARS +403 PROJECTS

INTECRO has delivered more than 403 projects since its establishment.

ASSEMBLY AND HANDLING TECHNOLOGIES

- Mechanical Assembly
- Handling of Finished and Semi-Finished Products

WELDING TECHNOLOGIES

- **Pre-Processing**
 - Flame heating
 - Inductive heating
- **MIG / MAG Welding**
 - Single-wire
 - Tandem-twin
- CMT (Cold Metal Transfer)
- **TIG Welding**
 - Without wire feed
 - With wire feed
 - Plasma welding
- **Laser Welding**
 - Laser Spot Technologies
 - Laser/Laser-Hybrid (Coldwire / HotWire) Technologies
- **Spot Welding**
 - MFDC
- **Special Process**
 - Cladding
 - WAAM



Since its inception, **INTECRO** has provided a wide range of robotic automation solutions to many different industries. INTECRO's strategic business areas are **WELDING TECHNOLOGIES**, **METAL PROCESSING TECHNOLOGIES**, and **FLEXIBLE ASSEMBLY MANUFACTURING LINES**, which have emerged by adapting many different applications together.



CUTTING TECHNOLOGIES

- Laser Cutting
- Plasma Cutting

ROBOT TECHNOLOGY

• Software-Based Intelligent Robotic Process Tools

- Touch Sense from wire or torch
- Contactless touch sense
- Arc Sense
- Multi Layer
- Laser Seam Tracking/Finding
- Wint-Gap
- Wint-Touch
- Arc Voltage
- ReflexWeld (Adaptive Welding)
- Offline Programming
- Robot Teaching
- Kinetic Teaching
- Cleaning Station
- Torch Changer
- AUTO-Rtherm
- AWC QC
- RPS COMM
- AUTOCAL
- Self Programming
- DISIS
- Anomaly Detection Tool

• Robot Types

- Gantry Robot
- Pillar Robot
- Gantry-Pillar Robot
- Portal Gantry Robot
- Positioners: 1 to 5 axis workpiece positioners:
 - Sky hook, H type, K type, Drop Centre and others
- 3 different types of robotic slider
- C type column and additional axes
- Synchronous systems up to 64 axes
- Single control point for multi-robot
 - (master / slave or master / master)
- Integrated fixture and safety automation

• Self Programming Technology

Navigating the Project Journey: From Inception to Completion



Analysis

INTECRO engineers review the workpieces and the material flow on the production floor at the customer site. INTECRO develops the optimum system configuration and process solution after a detailed data evaluation. The customer is also informed about possible revisions that would increase the workflow efficiency and better adapt the workpiece for the robot system.



Feasibility

The system requirements are calculated using welding requirements, metallurgical data, cycle time, and geometric analysis, using offline programming methods where necessary. The calculations and findings are presented to the customer in a "Return on Investment Report (ROI)."



Quotation

The quotation is prepared upon the customer's approval of the system concept. As a result of the pre-studies and attention to detail described above, our project proposals are created with a project management discipline, considering all related technical and commercial aspects.



Simulation Assisted Design

System concept and preliminary designs are used as inputs for 3D simulations, which run parallel with the design work. Project design is initiated by utilizing the accumulated solution inventory and engineering library while adding job-specific components as necessary. The design process is completed after the final simulation run and customer approval. Production drawings are prepared following the design freeze.



Final Simulation

All project details are determined in the project's beginning phase using 3D Simulation software. Details such as cycle time, collision tests, workpiece access, kinematic and axial orientation, singularity, and programming validation are revealed.



Production

Production drawings are transferred to the workstations using offline programming and CAMCAM cutting, welding, and machining techniques. Project-specific components such as fixtures and special-purpose machinery are manufactured meticulously with the highest quality control standards. Serial production components such as robot peripherals are welded in our robot line.



Purchasing

All standard components are procured from suppliers with international credibility. The ongoing business between INTECRO and its suppliers has evolved into a "partnership."



Assembly and Pre-Acceptance

The complete system performs quality control and function tests according to ISO 9001 and CE standards after assembling robotic equipment, standard products, and semi-finished products. Pre-acceptance procedures and dry runs are completed in the presence of the customer. Wet runs and test production is performed when necessary. A preliminary acceptance protocol is signed before system shipment.



Machine and System Commissioning

Upon delivery of the equipment to the customer site, INTECRO specialists complete their tasks in their respective fields of expertise: Mechanical and electrical technicians complete assembly. The automation unit acts on behalf of the SPS automation and motion control requirements. The robotization unit performs kinematics and robot setups. The activity report is presented to the customer and project management units following the assembly and power-up of the system.



Process Implementation and Welding Technique

Welding engineers perform the process equipment integration. Welding/process tests and trial production runs are performed. INTECRO process experts assist the customer during non-destructive and destructive testing to fine-tune the parameters and reach optimum results. The customer and INTECRO's project management unit sign the final acceptance report.



Training and Documentation

Robot operator, expert user, and maintenance training for the system and operator and expert level training for the process equipment are completed after final acceptance procedures. The system folder is handed over to the customer with all manuals, schematics, and quality documentation.



After Sales Technical Support

INTECRO's after-sales team performs remote diagnostics and on-site field support. A local service representative is forwarded to the site upon needing local support, backed up by a specialist from INTECRO when necessary.



Service and Spare Parts

Our goal is to provide our customers' systems with high MTBF intervals by fixing possible faults before they occur. Unexpected costs are avoided, and the lifetime of your system is extended through inspection and diagnostics. Service contracts are offered to our customers at different levels: Our standard service and maintenance contract includes annual periodic maintenance. In contrast, the "response-time contract" gives the customer peace of mind by receiving service intervention at the preferred time. Our customers also have the option to choose spare parts stock-delivery guarantee dedicated to their systems. The INTECRO service team works around the clock to establish a sustainable investment with high uptime for many years.

+ 15 YEARS + 403 UNIQUE PROJECT DESIGNS

In the last fifteen years, we have developed industrial robotic systems while obtaining patents and utility model protection rights to ensure serial production. **INTECRO** has produced hundreds of industrial technology products with more than 403 designs in the systems category. We continue to progress to develop a large number of qualified innovations that will be commercialized over time.



Competent

+ 214

EMPLOYEES

Founded in

2010

ANKARA, TÜRKİYE

Manufacturing Lines
Operating in

21

COUNTRIES

Sales & Service

INTECRO Robotics provides production solutions that are more flexible, sustainable, accessible, and profitable that consider each customer's unique requirements, including aspects such as product, quality, quantity, and process, which are implemented worldwide.

- Australia
- Austria
- Azerbaijan
- Belarus
- Croatia
- England
- Finland
- Germany
- Greece
- Hungary
- India
- Ireland
- Lithuania
- New Zealand
- Poland
- Russia
- Saudi Arabia
- Serbia
- Turkey
- USA
- Canada



INTECRO Robotics brings together **robotic technologies** and innovative **manufacturing processes** to deliver **integrated systems**

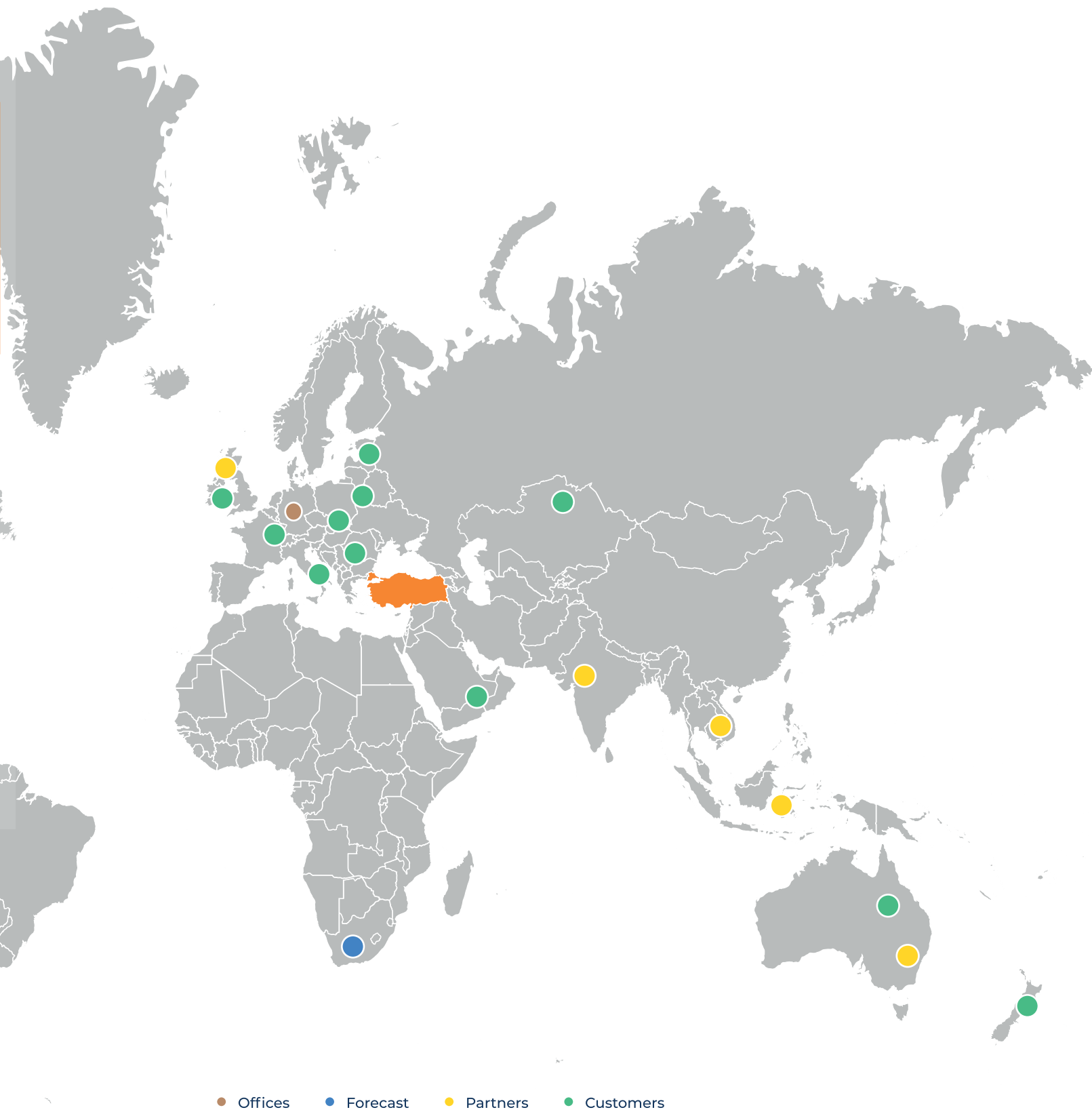

Robotic MIG/MAG Welding

Single / Tandem / Twin

We blend welding engineering, material science, global partnerships, and extensive application wisdom to craft the essence of INTECRO's specialization. Like pieces of a puzzle, these elements culminate in extraordinary welding precision and accelerated speeds, driven by impeccable welding regulation.

Introducing CMT, the exclusive MIG/MAG welding marvel. Defying norms, it welds metal sheets as thin as 0.5mm. Designed for brilliance, it slashes heat input by up to 90%, offering unparalleled stitching, penetration, and swift welding.

TECHNOLOGIES

Touch Sense

Touch sense is a sensing technique that works with analytical geometry algorithms that detect the position of the workpiece by receiving a signal from the welding wire, torch nozzle or an add-on probe.

Contactless Touch Sense

With contactless touch sensing, we can use a laser camera to remotely locate an edge or joint on the workpiece with no contact.

Multi Layer

Sensor and software technology for multi-pass applications.

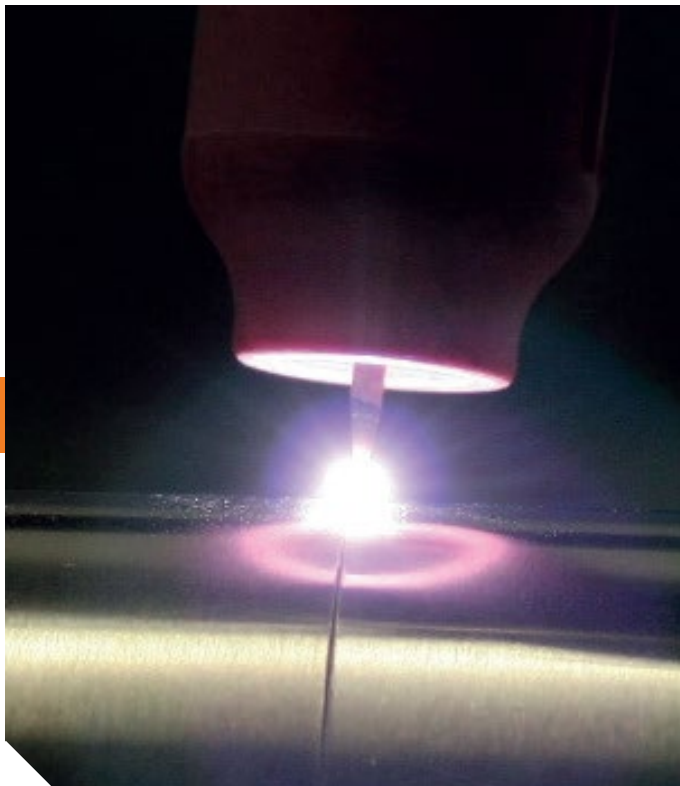
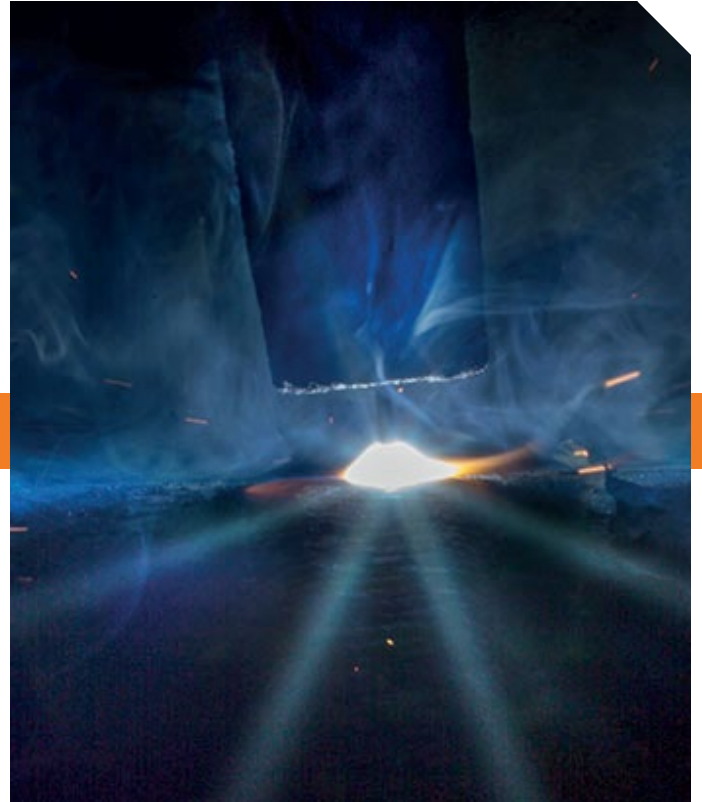

Robotic TIG Welding

With / without additional wire

Robotic TIG technology has been popular in stainless, aluminum, and other alloy groups. Manual TIG welding requires precise workmanship, making it an ideal candidate for robot welding, enabling you to enjoy high penetration, high speed, and minimum spatter with perfect accuracy. We are ready to offer advanced TIG process solutions for all industries with **Arc Voltage control technology** and robotic integrated **intelligent tuning systems** developed especially for thin and advanced materials.

TECHNOLOGIES

Arc Sense

Arc sense is a technology based on a sensor and software that follows the welding path in real time. It is used in the zig-zag welding method called "weaving". The basic principle is that it follows the welding path in real time according to the current measurement after the starting point is correctly detected by the robot.

Laser Seam Tracking/Finding

3D laser seam tracking allows welding on the required path by optically detecting and processing the reflection of a laser line, in cases where arc sensing is not feasible.

Robotic Laser / Laser - Hybrid Welding

Coldwire / Hot Wire / Std.

Nowadays the laser welding technology is becoming more and more important in terms of meeting high expectations such as speed, precision, strength, penetration and gap fill. INTECRO is always one step ahead with its turnkey Laser Welding technology. INTECRO engineers are ready to support you for welding your test samples and investment feasibility analyses.

TECHNOLOGIES

Wint-Gap

Wint-gap a sensor and software developed by INTECRO that monitors the welding path, gap width and gap depth in real time.

Arc Voltage

In TIG applications the current is stable while the voltage is variable. Arc-Voltage is used in multi-pass TIG welding in order to adjust the height of the weld seam. This technique is based on real-time sensing, signal processing, sensing and software algorithms.

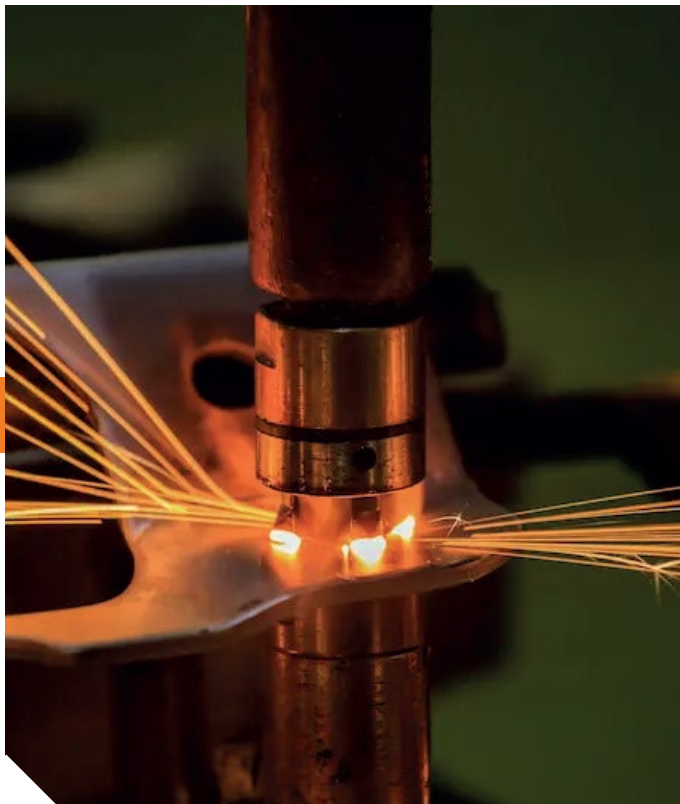

Robotic Resistance / Laser Spot Welding

MDFC / Fiber Laser

MFDC Timer and Laser Spot Welding applications are gaining popularity in automotive and other industries. In addition to the processes available today, the latest technology Laser-Seam-Stepper (LSS) or long stitch laser spot systems are on the way, enabling first-class industrial products applicable to robotics with safety advantages and no additional hardware or cost. INTECRO process engineers are ready to review your existing resistance welding operations and support your transition to the latest manufacturing technologies.

TECHNOLOGIES

Wint-Touch

3D sensor and software developed by INTECRO to detect the gap and welding starting point.

ReflexWeld

ReflexWeld is a software algorithm that automatically adjusts the welding parameters depending on changes in gap width and depth change to counter-act errors occurring during weld preparation.

Robotic Laser Cladding

Single / Tandem / Twin

Witness INTECRO's pioneering spirit in action with Robotic Laser Cladding. Our fusion of robotics and laser precision transforms cladding. Powered by engineering, material science, and global expertise, we lead the charge.

INTECRO's robotic mastery shines, creating coatings on intricate surfaces through powder/wire cladding. Laser energy elevates durability, protection, and aesthetics. Coatings as thin as 0.5mm shine, with up to 90% less heat input. Experience the future of manufacturing with INTECRO's Robotic Laser Cladding."



TECHNOLOGIES

Offline Programming

Robot programming and teaching via Virtual Program Interface (PC based robot teaching via control terminal).

AUTO – Rtherm

Automatic temperature measurement system developed by INTECRO. This technology used during the preheating process measures temperature in a contactless fashion using a laser sensor. The pre-programmed system can automatically direct the heating system and the robot.



Robotic Wire Arc Additive Manufacturing (WAAM)

Single / Tandem / Twin

INTECRO specializes in robotic additive manufacturing and has a holistic approach to problem-solving that includes advanced toolpath strategies, real-time process monitoring, adaptive process control, materials science, and a process parameter library suitable for different materials as well as various geometries. Utilizing this all-encompassing strategy, INTECRO is creating robotic additive manufacturing systems with possibilities for various research levels and commercial production.

TECHNOLOGIES

Torch Service Station

This device performs cutting of the welding wire to a standard length, cleaning the inner and outer surfaces of the nozzle and the welding tip, and spraying an anti-spatter agent inside the nozzle after a set number of workpieces are welded.

Tool Changer

It is the technology that automates the switch-over between different process tools and welding torches during robot operation.

Robotic Laser / Plasma Cutting

INTECRO has developed the first-of-a-kind solution in Turkey, where the combination of robot and laser technology with control engineering has created a process that is as efficient and more flexible than standard cutting machines: **Cad / CAM Controlled 3D Robotic Laser Cutting System**.

With this technology, it is possible to obtain excellent path accuracy for holes as low as 5 mm in diameter. This system makes it possible to perform cuts in difficult to reach locations, with much more favorable conditions than standard machines and additional superior features.

TECHNOLOGIES

AUTOCAL

INTECRO developed sensor and software technology for automatic torch height and torch angle adjustment.

RPS COMM

The technology combines the operation of the robot, welding machine and all other peripherals into a single control terminal.

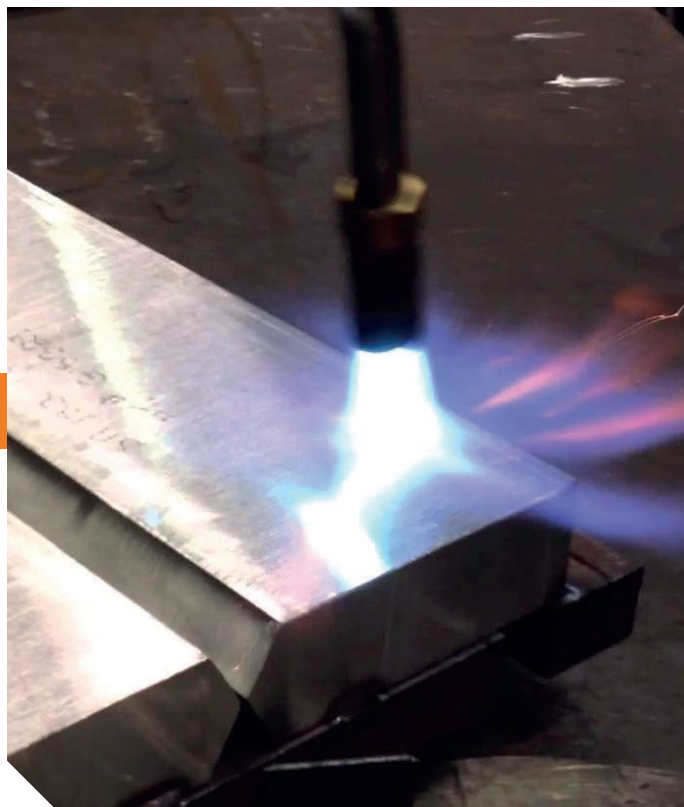
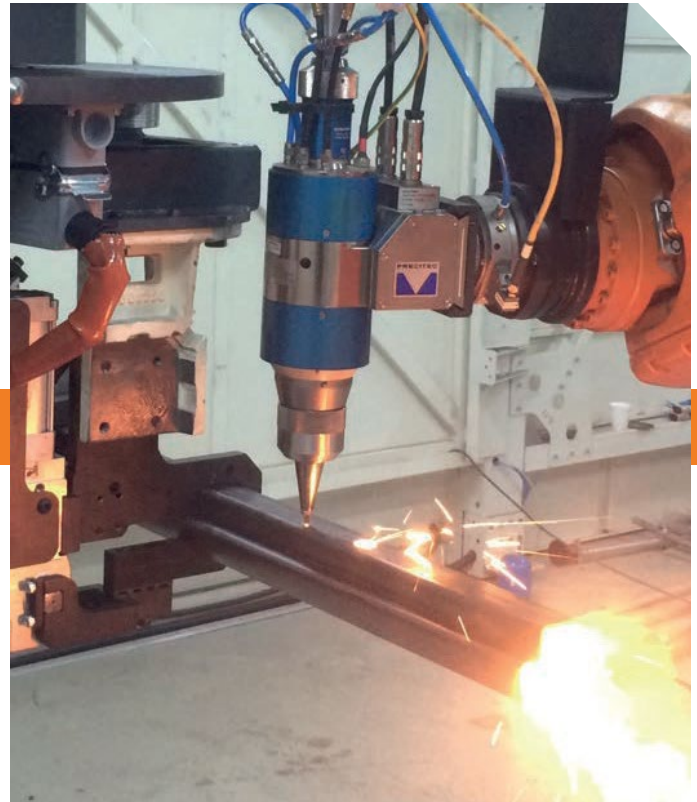

Robotic Preheating

Materials with higher thickness and thermal conductivity tend to be susceptible to hydrogen brittleness in the case of rapid cooling. Hydrogen brittleness can often occur under and on the sides of the penetration zone and transverse cracks can occur even days after welding. Preheating reduces the cooling rate by preparing the main material against these events, thus revealing a ductile structure.

Programmable, temperature-controlled and automatic oxy-acetylene (flame) or inductive heating methods can be used prior to robotic welding for this purpose.

TECHNOLOGIES

AWC QC

It is a sensor developed by INTECRO for performing quality control after welding. The sensor checks the presence of the weld seam regardless of the metallurgical properties of the weld.

+15 YEARS + 403 R&D PROJECT

15 YEARS 403 R&D PROJECTS INTECRO is an R&D center that has completed numerous projects for eight years. Of these 403 projects, 32 have been engineered into commercialized systems for serial production.

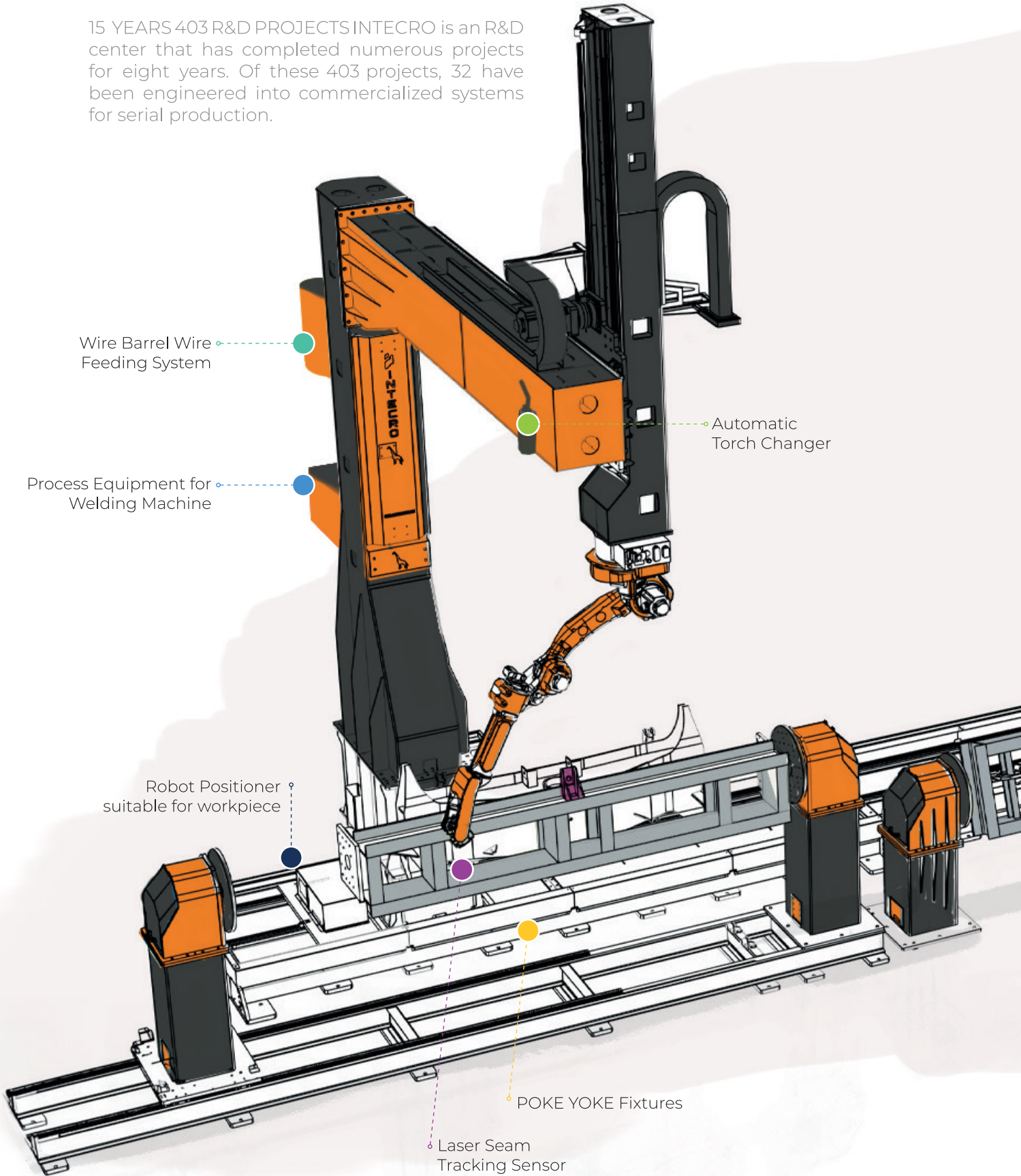

Wire Barrel Wire Feeding System

Process Equipment for Welding Machine

Robot Positioner suitable for workpiece

POKE YOKE Fixtures

Laser Seam Tracking Sensor

Automatic Torch Changer

SAMPLE ROBOT CONFIGURATION:

Gantry-Pillar Robot System with 3 stations and 13 axis

As compared to a conventional gantry system,
reduced cost,
increased performance and capability.

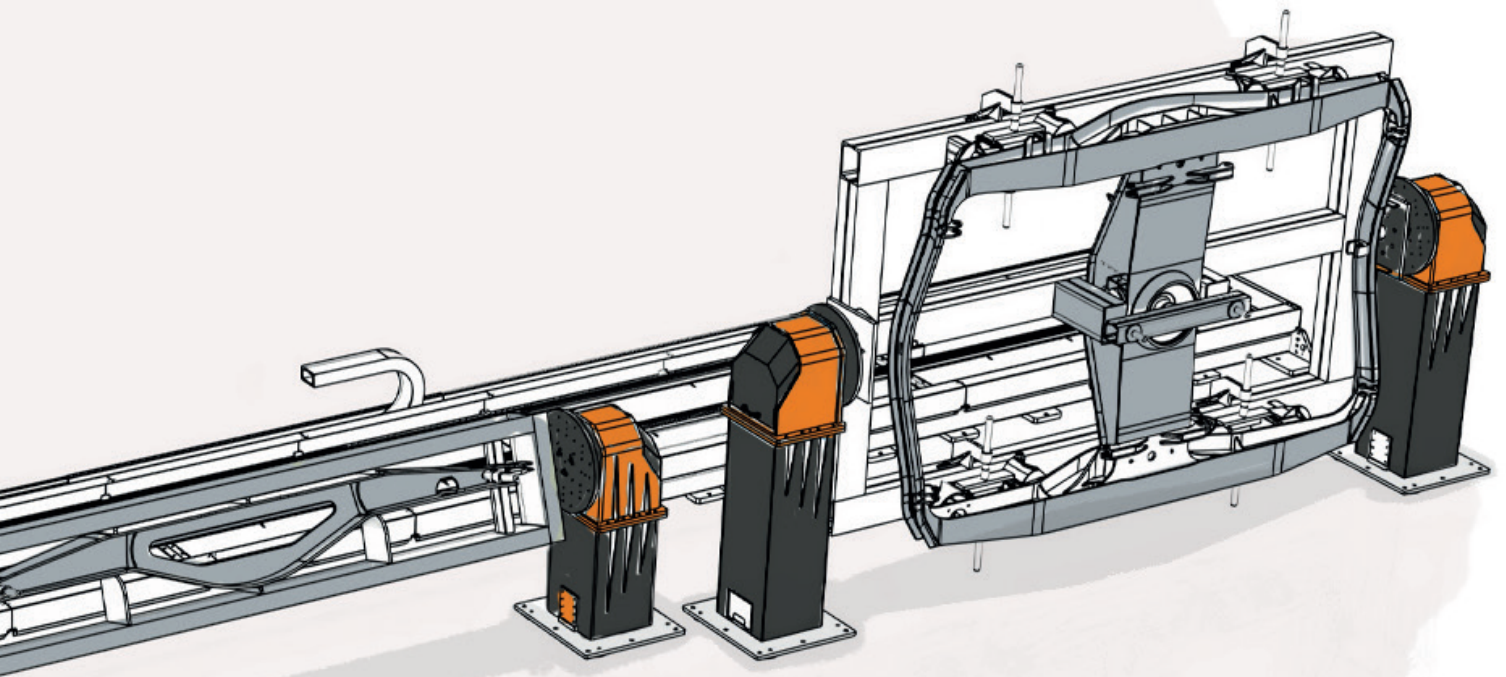

Client's Aspiration + 1:

Industry representatives and industrialists are very clear about their expectations:
 $A + B + C + X + Y + Z$

Y: Low Production Costs



B: Capacity Increase

C: Quick ROI

A: Low Initial Investment Cost

X: Quality

Z: Safety

INTECRO

We know our customers' expectations. The experience, versatility and experience accumulated in our portfolio puts forward the +1 factor. To simply deliver more, INTECRO adds + 1 to the solution.



Y+1: Cost-effective production with continuous savings.

B+1: Provides not only capacity increase but also scalable capacity management.

C+1: Global competitiveness through strategic investments.

A+1: Provides competitive and affordable options in terms of initial investment cost.

X+1: Promises high quality that is also sustainable.

Z+1: Environmental and employee safety ensured.



RAILWAY AND WAGON INDUSTRIES

EXPERTISE

- CARGO WAGON CHASSIS
- BOGIE SIDE AND FRAME WELDING
- BOGIE FINAL WELDING
- RAILWAY CARRIAGE DOORS
- ALUMINUM PASSENGER PANELS AND WALLS
- ALUMINUM PASSENGER CAR BODY

A large number of finished and semi-finished products are manufactured using aluminum extruded and steel sheets, which are two basic materials in the railway car industry. INTECRO uses its expertise in the railway industry with robotic welding and assembling technologies specific to both material groups.



Hydraulic and pneumatic fixtures have been designed to deal with part deformations induced by heat input. Welding parameters and material properties are roughly calculated prior to fixture design in order to bring the part to dimensions after welding. INTECRO has developed special solutions with electro-mechanical fixture designs for the fixation of work pieces where dimensional changes will be observed.

INTECRO welding an entire railway car with a 20-axis Gantry Robot. Despite the size of the parts, the team enhances the robot's independence by incorporating touch-sense, arc-sense, and laser-beam seam tracking sensors. This precise positioning before welding is truly impressive.

CUSTOMER FEEDBACK

VAKO VAGON



We chose INTECRO for our first robot investment because of the flow of information in the sales process, the solution proposal for our needs, and their well-equipped team. Thus we have chosen INTECRO for our second gantry robot line investment for bogie manufacturing, thanks to the confidence we gained in INTECRO for turning our first gantry robot investment into success.



Serhat KALAYCIOĞLU - CEO



HEAVY-DUTY COMMERCIAL VEHICLES

EXPERTISE

- TRAILER CHASSIS
- PICK-UP CHASSIS AND BODY
- BUS SIDE AND ROOF FRAMES
- FUEL TANK, AXLE PRODUCTION
- BRAKE PADS AND DRUMS
- SEAT CHASSIS
- VEHICLE AND PASSENGER SAFETY COMPONENTS
- AIR CONDITIONER BODY
- CASES, COVERS AND WHEELS

INTECRO promises perfect joining solutions for all lower and upper body groups, especially with metal content. Imagine personalized production with work-specific fixtures and system design. INTECRO is ready to deliver your turnkey Welding and Metalworking solution.



Flexible production lines utilize multiple processes at once, including image processing, quality control, component verification, assembly, lubrication, sealing, torque-controlled bolt tightening, and more. INTECRO's production and assembly lines are equipped to handle all of these tasks autonomously, working with various types of workpieces in the Industry 4.0 framework.

CUSTOMER FEEDBACK

DEUTZ / ERKUNT



As our first robot investment, we were considering a machine tending project for our CNC machining line. After discussing our short, mid, and long-term goals with INTECRO, this project expanded in content, and the idea of a "flexible production line" was born. From assembly to quality control, handling to surface machining applications, we now have almost all production steps in one integrated line. INTECRO has shown us that we can do much more than we thought with industrial robots. We will be expecting even more in our next investment.

Oktay BAŞARIR - Purchasing Manager



INTECRO, being its first kind in Europe, has developed and delivered the "Robotic Flexible Production, Assembly and Transfer System" for commercial vehicle diesel engine production.



STRUCTURAL STEEL AND CONSTRUCTION

EXPERTISE

- CONSTRUCTION MOLDS
- SCAFFOLDING AND OTHER EQUIPMENT
- POWER PLANT COMPONENTS
- CONCRETE PLANTS AND MACHINES
- PIPE LINES
- STRUCTURAL STEEL AND CONSTRUCTION
- ASPHALT PLANT EQUIPMENT
- WALKING PLATFORMS AND SAFETY BARRIERS
- OTHER CONSTRUCTION EQUIPMENT

In areas where thick materials are prevalent, the traditional oxy-acetylene technique or inductive pre-heating is utilized to regulate thermal expansion. You can manage plasma cutting, pre-heating, and various welding procedures, including single wire, tandem, and twin welding, in a single system. This system, coupled with two or three workstations and positioners, enhances productivity and simplifies material handling. Additionally, consolidating multiple machines into a single robot system saves valuable floor space on the production floor. For additional information, please contact our sales engineers.

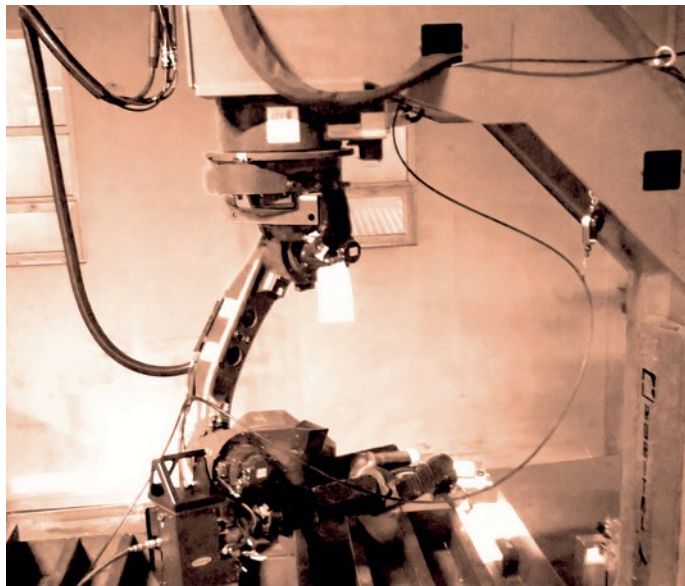

To avoid the distortion of parts that may occur due to the thermal expansion in steel construction welding, multiple robots work together to perform synchronous welding. This helps to manage warping effects. To simplify the programming of this process, CAD/CAM-based data processing is utilized. Additionally, offline programming is employed to minimize the programming time for manufacturing steel beams and other construction components. This approach is particularly useful when dealing with many different parts and the limited capacity for serial manufacturing.

CUSTOMER FEEDBACK



TOBLER / OKURSOY

Our first robot investment turned out to be a system with low uptime and provided minimal added value to our production. After meeting INTECRO and successfully completing the tests for our challenging process, we placed an order for 3 different systems. INTECRO is a highly reputed company with responsibility for service and after-sales support. For us, INTECRO is the company of choice for robot investments

İzzet OKURSOY - OKURSOY TOBLER A.Ş. / Chairman of the Board



INTECRO has implemented the Cold Material Transfer (CMT Advance) application for Aluminum modular scaffolding systems, reducing heat distortion.



CONSTRUCTION MACHINERY

EXPERTISE

- EXCAVATOR BUCKETS
- BOOMS AND ARMS
- FORKLIFT COMPONENTS
- MOBILE CRANES AND PLATFORMS
- TRASH COLLECTION AND COMPACTING SYSTEMS
- TANKERS
- DUMP TRUCKS
- STATIONARY AND TOWER CRANES

INTECRO adds value to numerous construction machine manufacturers' products with their systems equipped with tool changing, pre-heating, single-wire, and tandem/twin welding techniques. Additionally, their innovative approach ensures seamless integration and optimal performance in complex manufacturing environments.



To ensure accurate results in the construction machinery segment, it's important to utilize a combination of arc sensors, touch sensors, and laser sensors. These high-tech tools work in tandem to provide precise measurements and data, ultimately leading to a successful outcome. By incorporating all three sensors, you can achieve unparalleled accuracy and precision in your construction projects.

CUSTOMER FEEDBACK

MPG Makina



Persuading management may turn out to be a lengthy task in companies that are in transition to robotic welding. We discussed our expectations and goals for this transition with numerous domestic and foreign robot integrators. One of the main reasons why we were convinced to work with INTECRO is that they understood our needs and provided us with a concept that would enable a short ROI. On the other hand, INTECRO has a wide range of workpiece and robot positioners that are suitable for high-volume workpieces and heavy welding applications. INTECRO's team of welding engineers proved their expertise in the process.

Veyssel ALVER - MPG Makina A.Ş / General Manager



INTECRO is one of the leaders in "Heavy Welding Applications."



AGRICULTURAL EQUIPMENT

EXPERTISE

- AGRICULTURAL MACHINES
- SEMI-AUTOMATIC TOOLS
- TRACTOR ATTACHMENTS
- EQUIPMENT SILOS
- HAND TOOLS AND MECHANICAL SYSTEMS
- MILLING AND SCREENING SYSTEMS

Maintaining impeccable standards is crucial for successful robotic welding, particularly for sub-components. Precision is of utmost importance, requiring exact cutting and bending tolerances for intricate workpieces that demand flawless fixation. INTECRO's turnkey solutions for robotic welding provide the foundation for victory. Our Precision Robot Technology covers the entire process, not just welding. We utilize CAD CAM control for laser cutting and offline programming for 3D workspace, ensuring perfection before welding even commences.

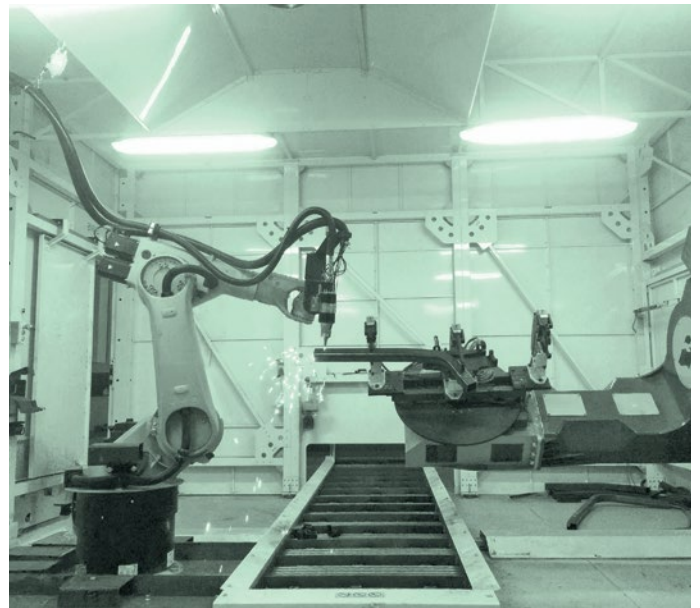

The precision of the robot trajectory is one of the most important factors in the laser cutting process. The laser beam must have a precise path and positioning accuracy as well as repeatability. CAD-CAM supported programming interfaces is the only alternative in creating robot frames.

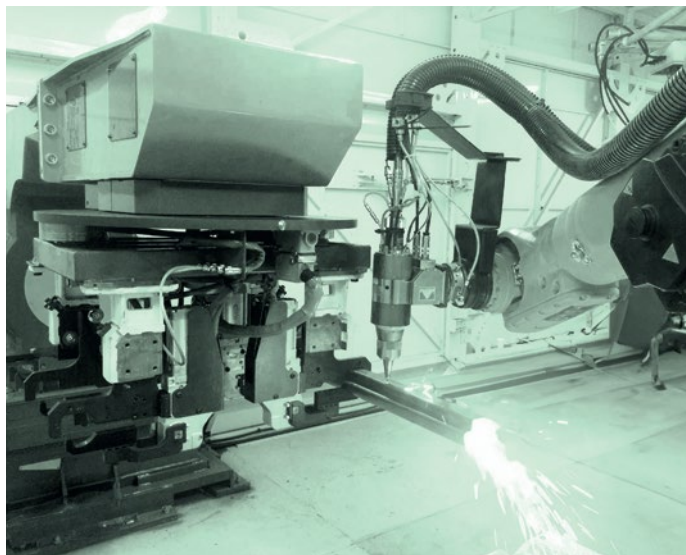

3D Robotic laser cutting technology assisted by CAD-CAM requires no point-to-point teaching. INTECRO's recent laser-cutting system processes steel tubes, pipes, and profiles in various shapes and dimensions. Cutting jobs for all 36 different workpieces are carried out in a single flexible manufacturing cell using 24 quick-connect fixture systems.

CUSTOMER FEEDBACK

EKER-MAK



Due to the number of parts and the need for tack welding, we used to think that it would not be possible to weld our agricultural machinery products by robots. INTECRO proved the opposite. With robotic positioners and robotic slider systems that we use in our welding line, we now enjoy the advantages of flexible production. We strongly recommend other manufacturers to consult with INTECRO before making the move to robotized welding.



Ahmet TEKBAŞ - EKER-MAK AGRICULTURAL PRODUCTS / Deputy General Manager

SHIP & OFFSHORE MARINE

EXPERTISE

- AUTOMATIC ROBOTIC WELDING FEATURING ADAPTIVE INTELLIGENCE
- ROBOTIC PIPE SHOP
- AUTOMATED SPOOL WELDING LINES
- PANEL WELDING LINE
- GOLIATH BLOCK WELDING LINE
- WEB AND MICRO PANEL WELDING
- PLASMA & OXY-FUEL PIPE CUTTING, SPRAYING AND WELDING SYSTEMS

The importance of efficiency and precision in the shipbuilding industry is increasing. INTECRO meets this need with high-tech robotic welding systems developed specifically for shipyards. Our systems equipped with image processing technology automatically create welding programs by scanning prefabricated and web panel parts and transmit the robot codes they produce to the robot to perform perfect welding processes.



Embrace sustainability with our energy-efficient systems, contributing to eco-friendly practices in ship and offshore construction. Elevate your shipbuilding and offshore marine ventures with our innovative robotic welding solutions – where technology and expertise converge for excellence.

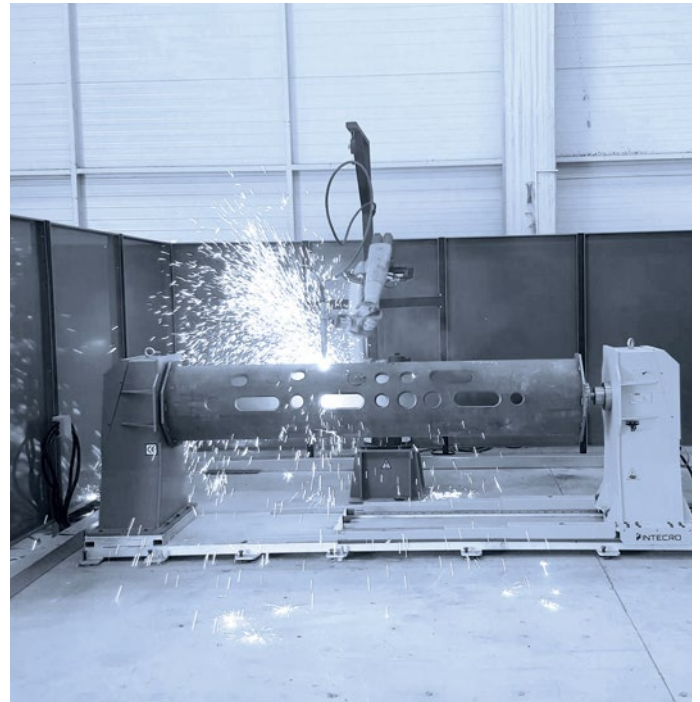

This innovative approach significantly reduces labor costs and production time while improving quality by eliminating manual welding errors. Modernize your shipbuilding processes and gain a competitive advantage with our INTECRO robotic welding systems designed to withstand harsh environments and resist offshore corrosion.



TIER-1 AUTOMOTIVE SUB-SUPPLIERS

EXPERTISE

- AXLE COMPONENTS
- ENGINE FRAMES, TRANSVERSAL COMPONENTS
- SEAT PARTS
- CRASHBOX
- ISOFIX CONNECTIONS
- DRAWBAR
- DOOR AND LUGGAGE LOCKS
- BODY AND SUB-CHASSIS GROUP

The functionality of the welding fixture is the main factor for repeatable production in automotive. Part dimensions and part preparation are key features of the automotive industry. While INTECRO uses POKEYOKE and 3S techniques in fixture designs, the manufacturing and assembling of fixtures are verified by CMM methods with controlled reference metrics at every stage of production. INTECRO focuses on turnkey solutions for the automotive industry with an understanding of industry standards.



INTECRO is a single-source solution provider for all necessary components in a robotic manufacturing cell. For the automotive industry, the process and all peripherals such as fixtures, special machinery and positioners are designed, manufactured and integrated into turnkey solutions

CUSTOMER FEEDBACK

TOYOTA / TI: ARIKAN AUTOMOTIVE



Due to the number of parts and the need for tack welding, we used to think that it would not be possible to weld our agricultural machinery products by robots. INTECRO proved the opposite. With robotic positioners and robotic slider systems that we use in our welding line, we now enjoy the advantages of flexible production. We strongly recommend other manufacturers to consult with INTECRO before making the move to robotized welding.



Ahmet ARIKAN - Arıkan Otomotiv A.Ş
Chairman of The Board

INTECRO's standard plug and play arc welding cells and spot welding systems offer flexibility on the manufacturing floor as well as saving floor space with its compact design.



GENERAL INDUSTRY

EXPERTISE

- ENERGY
- CABLE INDUSTRY
- HOUSEHOLD APPLIANCES
- FURNITURE
- CONSUMER ELECTRONICS
- MEDICAL



Metal joining and flexible production lines are used in the main industries of INTECRO as well as in the general industry segment such as furniture, energy, household appliances, medicine and consumer electronics.

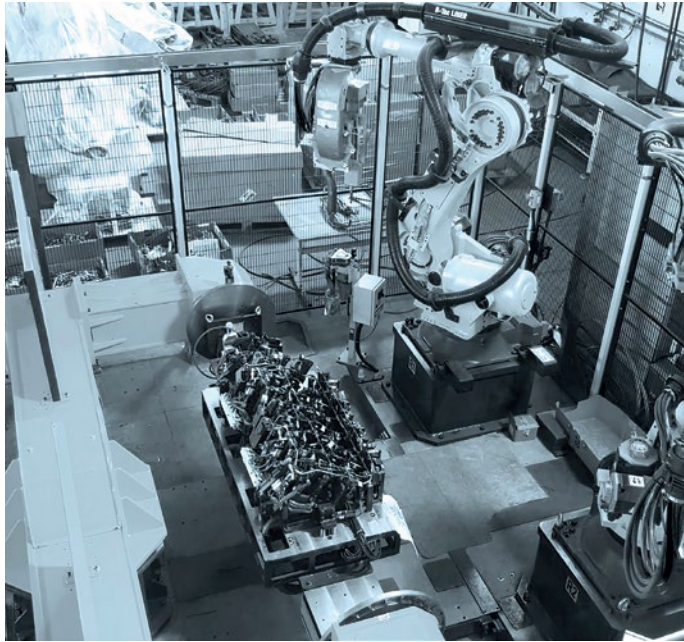

INTECRO is a single-source solution provider for all necessary components in a robotic manufacturing cell. For the automotive industry, the process and all peripherals such as fixtures, special machinery and positioners are designed, manufactured and integrated into turnkey solutions

CUSTOMER FEEDBACK

HES KABLO



"INTECRO's packaging line turned out to be quite reliable and has now been working for 5 years without any problem. The system is autonomous. It can make decisions, automatically create recipes, produce the n-barcode after each operation and direct production in preceding steps with the help of machine vision. The whole factory is mobilised in line with SAP data, and the results are fed back into SAP. INTECRO did not only engineer and deliver a system with such complex mechanical, electronic and software engineering but also delivered a perfect after-sales experience thanks to the service interventions being handled in a timely manner."



Uğur YILDIZ - Hes Kablo A.Ş / Production Manager

Back in 2012, INTECRO accomplished a great feat by developing a flexible packaging line that could handle various product types concurrently. This groundbreaking project was the first of its kind in Turkey and was fully integrated into the customer's ERP system. Little did we know at the time that what we had achieved would later be referred to as Industry 4.0.



ACCOMPANYING ACCOMMODATION: FULL PENETRATION WELDING

EXPERTISE

- PRESSURE VESSELS, STEEL STRUCTURES
- THERMODYNAMIC PRODUCTS AND MACHINES
- HEATING SYSTEMS
- FUEL TANKS
- DEFENSE INDUSTRY PRODUCTS
- SILOS AND TANKERS

INTECRO, along with Robotic solutions, plays a crucial role in ensuring that all necessary operations are carried out before welding, with careful consideration of important factors such as material composition, part geometry, and weld preparation. By selecting the most appropriate filler material, our team is able to achieve optimal penetration through single and double-sided weld deposition on top of the root in various welded geometries such as V, Y, K, and X, with or without backing material.



In robotic applications, it is necessary to have a deep process know-how to control variables such as material information, appropriate welding mouth selection according to material, welding current, speed, position, arc length electrode angle and diameter, and protective gas type to obtain a high strength welding seam.

CUSTOMER FEEDBACK

OTOKAR



At first we thought that INTECRO had signed a project contract which we thought it would be very difficult both in terms of robot mechanics and process. They were able to deliver our biggest gantry system investment in just 2 months, fully functional, and consisting of a 30 meters gantry with two work stations. The INTECRO team worked day in day out with full dedication as a part of our company in process improvements. It is a company with high engineering ability that analyzes all the variables before welding on a daily basis and achieves the expected sustainable welding penetration success average without stopping the production flow and catching the x-ray penetration values in the expected rate.



Ferda TEKİN - Otokar Automotive and Defense Industry Inc.
Production Manager

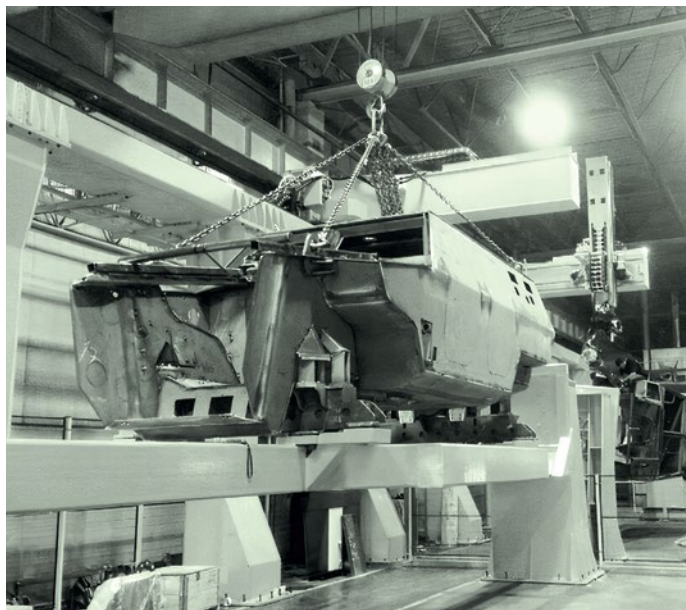

INTECRO has achieved a groundbreaking feat in the welding industry. Our team and technology partners successfully delivered a 30-meter, 20-axis gantry system in November 2016, making us pioneers in the field. This system is capable of providing full penetration in serial production conditions with 95% X-ray control, especially when welding unique alloy materials such as armor steel. We take immense pride in being one of the few distinguished manufacturers in the world that have achieved such high standards and bringing this revolutionary technology to the industry.



DISIS

I am DISIS,
INTECRO's platform applicable
to all the smart #hashtags!

Digital Transformation System for
the Smart Factories of the Future

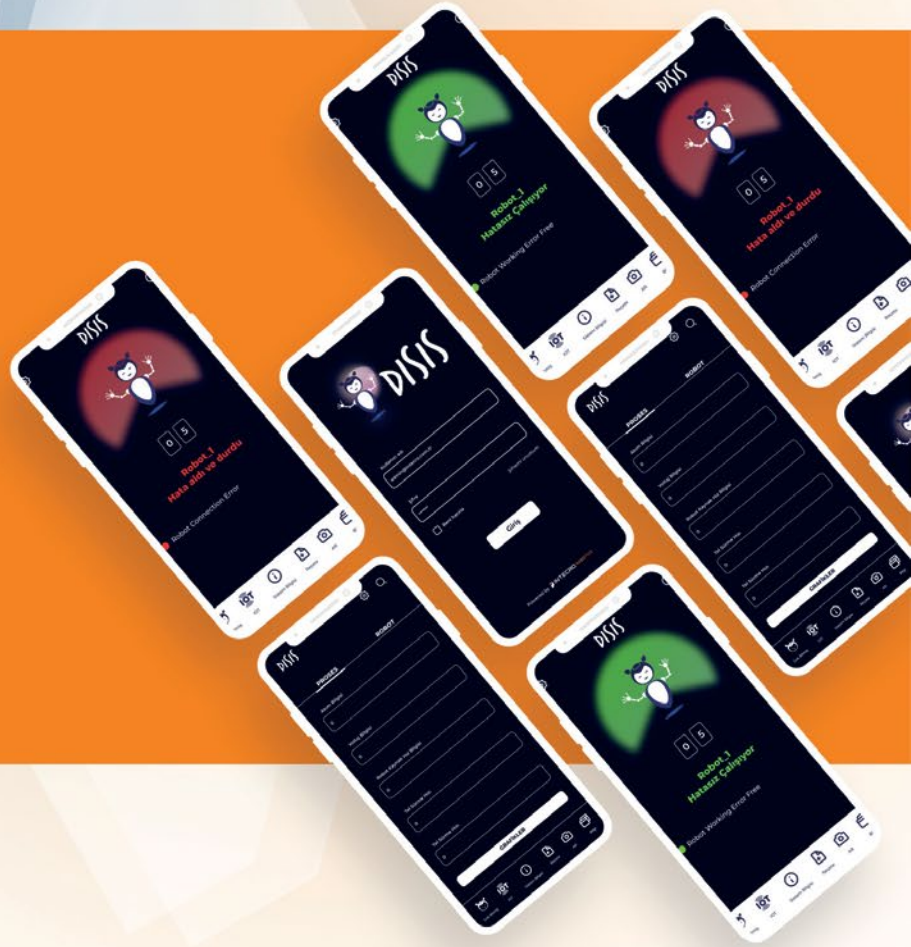

INTECRO ROBOTICS Augmented Reality Application DISIS

INTECRO ROBOTICS has developed an AI and AR-supported mobile application to ensure advanced traceability of robotic systems.

Using INTECRO's developed software, users can access various components such as the production and operational data of the robot through mobile platforms and store their data.

Advantages

- ✔ Ease of use
- ✔ User-friendly interface
- ✔ AI-supported data analysis
- ✔ Quick access to robotic system data
- ✔ Advanced traceability of robotic systems
- ✔ Ease of data storage for robotic systems
- ✔ Robotic system warning and error log records
- ✔ Quick solutions with augmented reality-based maintenance and repair instructions and guidance
- ✔ Robotic system guidance and instructions for operators

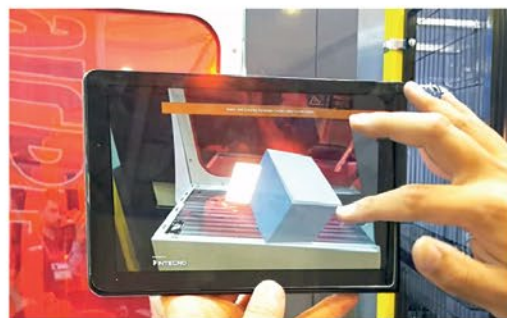

INTECRO

Is an Innovation Movement
That Turns the Idea of Providing
Technology-Based Benefits to
Humans and Nature Today and
In the Future into Reality.





From the construction machinery used in the building of your home to the car, you drive to work. From the elevator you use to reach your office, to the agricultural machines that bring your lunch to your plate. From the vehicles that collect your waste and create a clean environment, to the machines that process it and convert it into energy. From the passenger trains that allow you to reach your loved ones, to the radar systems that determine the route of your return flight. From the technologies that ensure your safety, to the electrical energy that lights up your night.

INTECRO's touch can be found in many moments of our daily lives.

INTECRO is in our lives.

Certificates



2023 - CE
MIG / MAG Welding

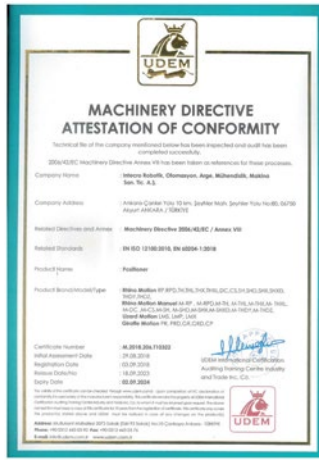

2023 - CE Positioner



2023 - 27001- 2013 BGYS



2023 - ISO 10002



2024 - ISO 45001



2024 - ISO 14001



2024 - ISO 9001



2023 Turqum
Certificate



2024 - CE Pack Line



2024 - CE Rotator

References

Sorted in alphabetical order

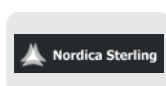
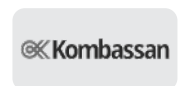
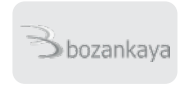



You can visit to get to know us better and see all of our links.

 info@intecro.com.tr

 intecro.com.tr

 +90 850 223 0 468 (INT)

 +1 (630) 948-8221

 **ANKARA - VIA TOWER MANAGEMENT - MARKETING - SALES OFFICE**

Söğütözü Mah. Nergiz Sokak No: 7/32
Yenimahalle 06560 Ankara/TÜRKİYE

 **ANKARA - YENİ BATI ADMINISTRATIVE OFFICE**

Yeni Batı Mah. 2400 Sokak No: 13
Yenimahalle 06370 Ankara/TÜRKİYE

 **ANKARA - EMAI MANUFACTURING - ENGINEERING CAMPUS**

Sarayosb Mah. Uzay ve Havacılık OSB
NO: 187AA K.Kazan 06980 ANKARA

 **CHICAGO - TTC USA SALES - SERVICE OFFICE**

11417 Irving Park Rd. Franklin Park
60131 Illinois USA



INTECRO and INDUSTRY 4.0

In 2012 we were convinced that we would establish "Robotics Systems" with our first SAP-integrated production line, which would shape our future for industrial production as a "TRANSLATED WORLD" and "PERSONALIZED PRODUCTION". We are focusing on the future with a high awareness to move the "Industrial Ecosystem" on a global scale into the industrial revolution.